

Installation Kit for frequency-control lifts WDGAS58E with end hollow shaft encoder



The following installation kits are available for fitting the encoder to a frequency controlled lift. Every installation kit consists:
1 x Encoder, 1 x with 15 m ready-made shielded cable, 1 x shaft adapter

Mechanical Data

Housing	
- Flange:	Aluminium
- Cap:	Aluminium, powder coated
- Torque Support:	
1. Spring plate	Incl. 1 spring plate WDGDS10001
Compensation:	axial: ±0.8 mm radial: ±0.2 mm
Max. operating speed:	6000 rpm

Hollow bore (blind)

- Material:	stainless steel
- Diameter:	10
- Permitted load on shaft end:	max. 80 N radial max. 60 N axial
- Starting torque:	approx. 1.6 Ncm at ambient temperature
- Attachment:	permanently attached clamping ring

Bearings

- Type:	2 precision ball bearings
- Service life:	1x 10 ⁹ revs. at 100 % shaft load 1x 10 ¹⁰ revs. at 40 % shaft load 1x 10 ¹¹ revs. at 20 % shaft load

Weight:

approx. 220 g

Connections:

SH8: radial connector, 8 pin

Protection rating: IP65
(EN 60529)

Operating temperature: -20 °C up to +80 °C
Storage temperature: -30 °C up to +80 °C

Machinery Directive: basic data safety integrity level

MTTF _d :	200 a
Mission time (T _m):	25 a
Nominale service life (L _{10h}):	1x 10 ¹¹ revs. at 6000 rpm and 20 % rated shaft load
Diagnostic coverage (DC):	0 %

Encoder-Order No.:	WDGI58E-YYYY-ABN-H24-SH8
	- YYYY: with 1024, 2048, 4096 PPR
	- 3 channels, A, B and zero marker pulse N
	- H24: 10 VDC up to 30 VDC HTL Power supply
	- SH8: radial connector, 8 pin
	WDGI58E-YYYY-ABN-R05-SH8
	- YYYY: with 1024, 2048, 4096 PPR
	- 6 channels, A, B, zero marker pulse N + Inv.
	- 5 VDC TTL Power supply with inv. output
	- SH8: radial connector, 8 pin

YYYY: Please specify required. PPR: 1024, 2048 oder 4096

- Easy installation on all motor shafts
- Flexible attachment possibilities
- Space-saving
- TTL, HTL output
- Threads: M8, M10, M12, M16 und M20

www.wachendorff-automation.com/wdgas58e

Installation Kit WDGAS58E:

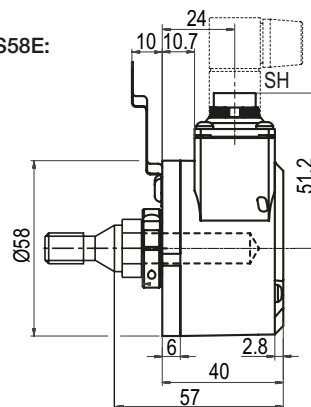

Cable:

The cable is 15m in length and is shielded, however the shield is not connected to the connector housing. With a mated connector, the encoder meets protection class IP40.

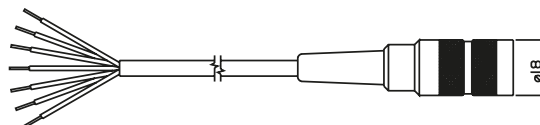

The cable has a connection as follows:

Function	Colour
Positive	brown
Negative	white
A	green
A inv.	red
B	yellow
B inv.	black
N	gray
N inv.	violet
Shield:	cable braiding

Order No.: KD84015

Pin identification SH8

Function	Pin HTL	PIN TTL
Positive	2	2
Negative	1	1
A	3	3
A inv.	-	6
B	4	4
B inv.	-	7
N	5	5
N inv.	-	8

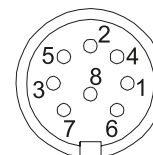

The view of the soldered side of the connector connector corresponds to the view of the pin arrangement on the encoder.

Shaft adapters



Note:

XX: Please insert the code corresponding to the required shaft adapter:

- Shaft adapter 10/M8: 08
- Shaft adapter 10/M10: 10
- Shaft adapter 10/M12: 12
- Shaft adapter 10/M16: 16
- Shaft adapter 10/M20: 20

YYYY: Please specify required PPR: 1024, 2048 or 4096

Shaft adapters:

The shaft adapters are screwed into an appropriate thread on the lift.

Ordering information WDGAS58E:

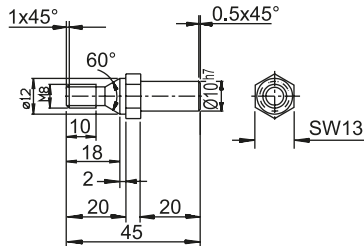

Shaft adapter M8

Order No.: WDGWA10M08

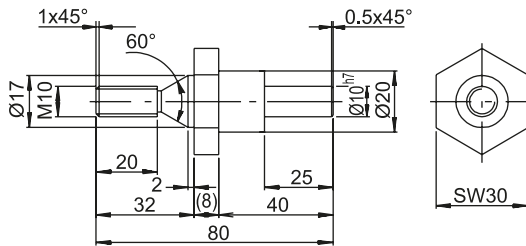

Shaft adapter M10

Order No.: WDGWA10M10

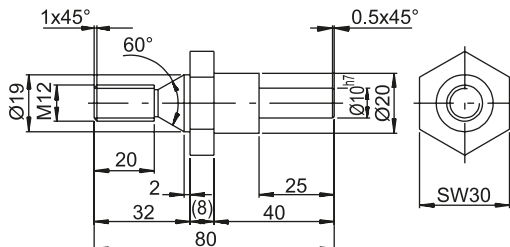

Shaft adapter M12

Order No.: WDGWA10M12

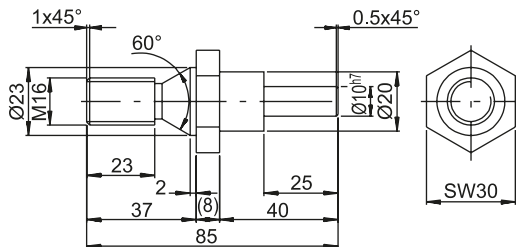

Shaft adapter M16

Order No.: WDGWA10M16

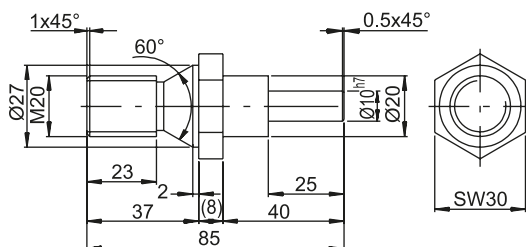

Shaft adapter M20

Order No.: WDGWA10M20

Description:	Order No.:
Installation Kit 10-30 VDC HTL comprising: - WDG158E-10-YYYY-ABN-H24-SH8 - YYYY: with 1024, 2048, 4096 PPR - 3 channels, A, B, N - H24: 10 - 30 VDC power supply - SH8: radial connector, 8 pin - KD84015: 15 m ready-made shielded cable - XX: Shaft adapter: 08, 10, 12, 16 or 20	WDGAS58EYYYYH24XX
Installation Kit 5 VDC TTL, RS422 comprising: - WDG158E-10-YYYY-ABN-R05-SH8 - YYYY: with 1024, 2048, 4096 PPR - 6 channels, A, B, N, A, B, N - R05: 5 VDC TTL power supply with inv. output circuit - SH8: radial connector, 8 pin - KD84015: 15 m ready-made shielded cable - XX: Shaft adapter: 08, 10, 12, 16 or 20	WDGAS58EYYYYR05XX

Customs tariff number: 90318020

Country of origin: Germany